

Powr-Flite[®]

OPERATOR'S MANUAL

WIDE AREA SWEEPER VACUUM

PF28SV



**WARNING: OPERATOR MUST READ AND UNDERSTAND THIS MANUAL
COMPLETELY BEFORE OPERATING THIS EQUIPMENT.**

Save These Instructions

Congratulations on your purchase of a Wide Area Sweeper Vacuum. You are now equipped to handle any and all commercial carpet cleaning jobs. Your new unit is a high quality, precision-made product. All parts used in the manufacturing of this unit have passed rigid quality control standards prior to assembly. Please safeguard the original receipt / invoice. If you experience any problems with your unit during the warranty period, the original receipt / invoice will act as proof of purchase.

Shipping and Damage

This equipment is thoroughly inspected, tested, and packaged to provide equipment in good operating condition. It is beyond our control after the equipment is turned over to a freight carrier. The freight carrier received and signed for the equipment in good condition. Consequently, it is most important to protect your interest by carefully complying with the following instructions: Please inspect your cartons for any damage (including concealed damage) that might have occurred during shipment. Any damage is the responsibility of the freight carrier and should be reported to the freight carrier immediately. It is your responsibility to issue a claim and to receive compensation from the freight carrier for any damage done in transit. Damage of this sort is not warranted.

Customer Record

Model Number: _____

Serial Number: _____

Date Purchased: _____



PROTECT THE ENVIROMENT
Please dispose of packaging materials in an enviromentally safe way according to local waste disposal regulations.

Always remember to recycle.

IMPORTANT SAFETY INSTRUCTIONS

This vacuum is not a household appliance, intended for commercial use only.

READ AND UNDERSTAND ALL INSTRUCTIONS BEFORE USING THIS UNIT

Read and understand this owner's manual and all labels on the unit before operating. Safety is a combination of common sense, staying alert, and knowing how your unit works. Use this unit only as described in this manual. Use only manufacturer's recommended attachments. To reduce the risk of personal injury or damage to your unit use only recommended accessories.

SAFETY WARNINGS AND PRECAUTIONS

1. Use only as instructed in this manual.
2. Do not leave appliance when plugged in. Unplug from outlet when not in use and before servicing.
3. Do not use outdoors or on wet surfaces.
4. Do not use to pick up liquids. This vacuum is for Dry Pickup only.
5. Do not use with damaged cord or plug. If appliance is not working as it should, has been dropped, damaged, left outdoors, or dropped into water, return it to a service center.
6. Do not vacuum up hard or sharp objects, as they may damage the vacuum bag or the vacuum motor.
7. Do not use without paper vacuum bag, cloth bag and filters in place.
8. Do not use with damaged cord or plug.
9. Do not kink or twist the power cord.
10. Do not pull or carry by the cord, use the cord as a handle, close a door on cord, or pull cord around sharp edges or corner. Do not run vacuum cleaner over cord. Keep cord away from heated surfaces.
11. Do not pull on the cord to unplug. Grasp and pull the plug, not the cord. Turn off the vacuum before unplugging.
12. Do not handle the cord, plug, switch or vacuum with wet hands.
13. Do not use outlets with inadequate current capacity.
14. Do not use an extension cord with this vacuum.
15. Do not put any objects into openings. Do not use with any opening blocked. Keep free of dust, lint, hair and anything that might reduce airflow.
16. Keep hair, loose clothing, fingers, and all parts of body away from openings and moving parts.
17. Use with extra care when cleaning stairs.
18. Do not use to pick up flammable or combustible liquids, such as gasoline, or use in areas where they may be present.
19. Do not use without dust bag in place.
20. Sparks inside the motor can ignite flammable vapors or dust. To reduce the risk of fire or explosion, do not use near combustible liquids, gases, or dusts, such as gasoline or other fuels, lighter fluid, cleaners, oil-based paints, or natural gas.
21. To reduce the risk of inhaling toxic vapors do not vacuum or use near toxic or hazardous materials.
22. Do not allow to be used as a toy. Close attention is necessary when used by or near children.
23. This machine is not intended for use by persons with reduced physical, sensory or mental capabilities, or lack of experience and knowledge.
24. Do not attempt to service the vacuum yourself. Repair by anyone other than an authorized repair service center may void the warranty.
25. Store the vacuum indoors in a cool, dry area.

This appliance must be grounded. If it should malfunction or breakdown, grounding provides a path of least resistance for electric current to reduce the risk electric shock. This machine is equipped with a cord having an equipment -grounding conductor and grounding plug. The plug must be inserted into an appropriate outlet that is properly installed and grounded in accordance with all local codes and ordinances.

WARNING: Improper connection of the equipment-grounding conductor can result in a risk of electric shock. Check with a qualified electrician or service person if you are in doubt as to whether the outlet is properly grounded. Do not modify the plug provided with the appliance - if it will not fit the outlet, have a proper outlet installed by a qualified electrician.

This appliance is for use on a nominal 115-volt circuit, and has a grounding plug that looks like the plug illustrated in sketch A.

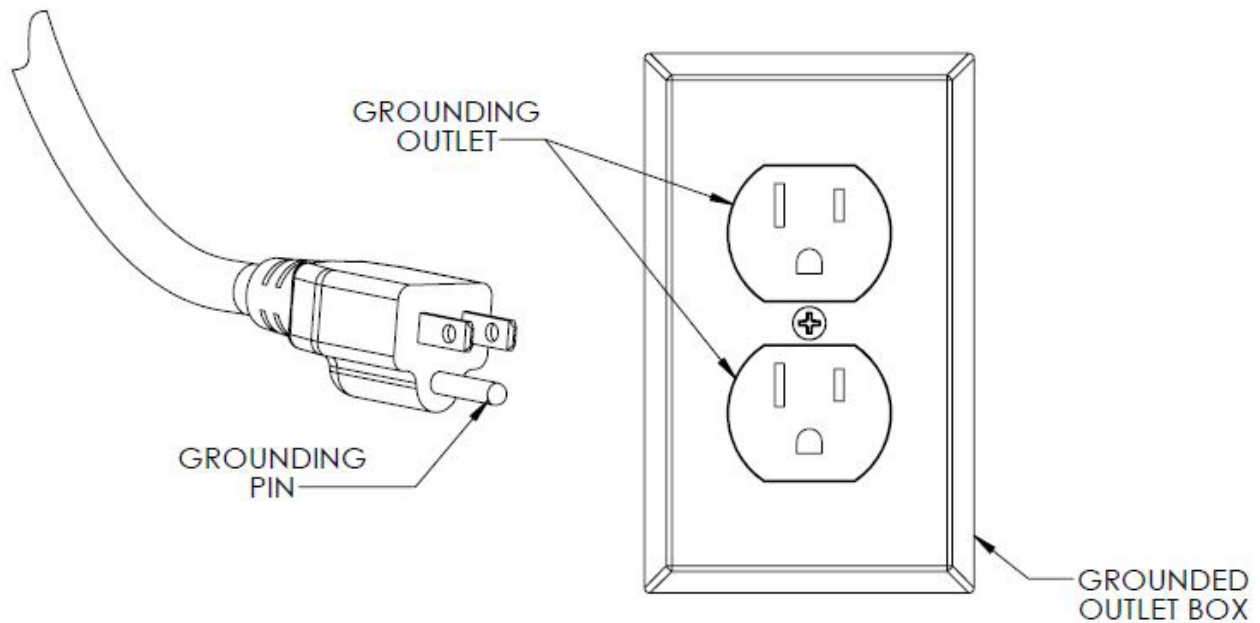

A

HANDLE ADJUSTMENT

1. Using the wing nuts (Fig. 1), adjust the handle length to a comfortable working position. Tighten all wing nuts.
2. Loosen the handle lock levers (Fig. 2) on both sides of the unit and adjust the handle to a comfortable operation height.
3. Tighten the handle lock lever on both sides to lock the handle in place.



Fig. 1



Fig. 2



Fig. 3



Fig. 4



Fig. 5

- ## BAG INSTALLATION
1. Attach the cloth zipper bag by placing the elastic opening seal securely around the neck of the exhaust opening. (Fig. 3)
 2. Connect the snap from the bag to the exhaust frame. (Fig. 4)
 3. Connect the two snaps in the front of the bag onto the top of the wide area vacuum sweeper.
 4. Unzip cloth bag and install the paper bag inside. (Fig. 5)
 5. Attach the paper bag onto the vacuum exhaust opening. (Fig. 6)
 6. Completely close zipper on the cloth bag.



Fig. 6

ATTENTION: Never operate machine without cloth bag.

Always use cloth and paper bags together.



Fig. 7

BRUSH HEIGHT ADJUSTMENT

1. This machine has 5 brush adjustment levels.
2. To lower brush height level: depress the lower pedal, Fig 8., down and release one notch of ratchet at a time to desired carpet height.



Fig. 8

3. To raise brush height level: depress the top pedal, Fig. 9, down to desired carpet height.

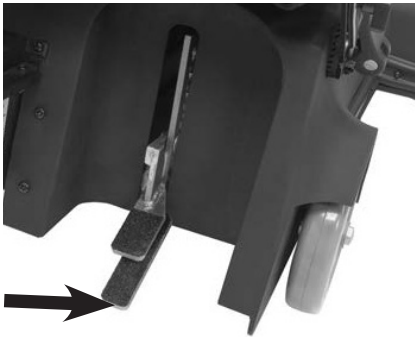

Fig. 9

4. When the machine is not in use, place nozzle in an up position to lift brush bristles off the floor to prevent damaging the brush bristles.

OPERATION OF MACHINE

1. Plug power cord into properly grounded power outlet.
2. To turn on machine, click the ON/OFF switch, Fig. 10, to the ON position.

NOTE: The vacuum does not turn on until step 3.

3. To operate brush and vacuum motor squeeze the brush start triggers.
4. Adjust brush height for proper pick-up.

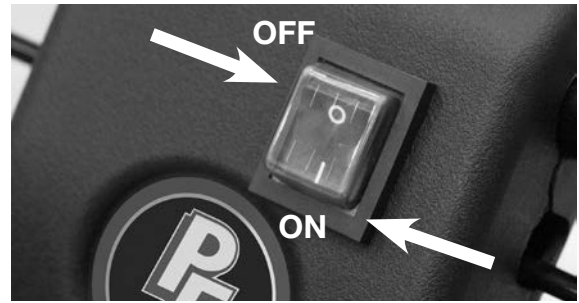

Fig. 10

3. To operate brush and vacuum motor squeeze the brush start triggers, Fig. 11.
4. Adjust brush height for proper pick-up.

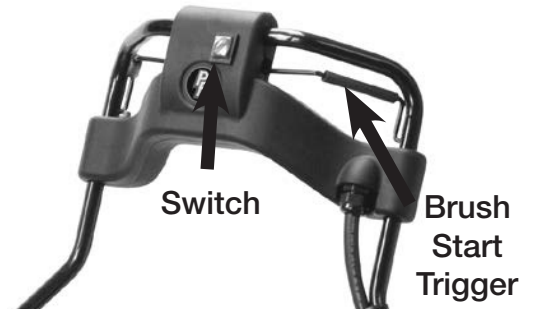

Fig. 11

CIRCUIT BREAKER



Fig. 12

Your new wide area sweeper vacuum comes equipped with a 15 amp manual circuit breaker, Fig. 12. If the machine does not turn on you will need to check the circuit breaker.

To reset circuit breaker:

1. Unplug the wide area vacuum sweeper.
2. Check machine for the following:
3. Full bag, obstructions, clogged brush, brush height set too low, etc.
4. Press the circuit breaker button to reset.
5. Resume operation.

BRUSH ROLL REPLACEMENT

Brush Roll Replacement for the Wide Area Sweeper

Tools:

- 4 mm Allen Wrench
- 10 mm Wrench

1. Detach belt cover by removing the 4 belt cover screws as shown in Fig. 13. This will expose the belt connected to the brush roll Fig. 14.

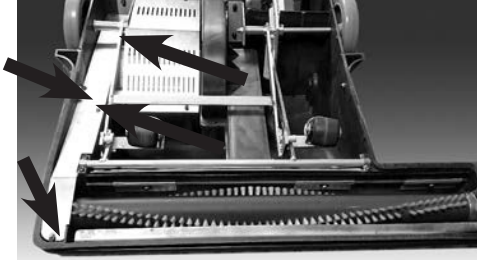

Fig. 13

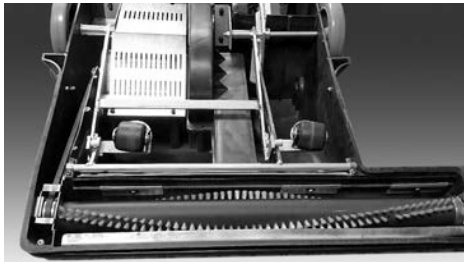

Fig. 14

2. Pull down bumper on long end of sweeper to expose screws, Fig. 15.



Fig. 15

3. With a 10 mm wrench, secure the nut inside of the brush roll and use a 4 mm Allen wrench for the screw, Fig.16. Loosen screws to release the brush from the vacuum.

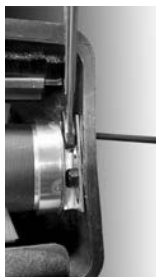

Fig. 16

4. Pull out old brush roll from the sweeper. This will release the tension from the belt Fig 17.

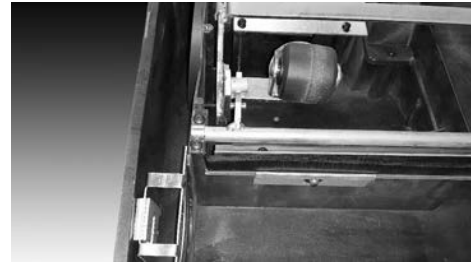

Fig. 17

5. Inert the new brush roll. Ensure the belt loops around the grooved end of brush roll and that there is tension in the belt Fig 18. The brush should be able to spin without any interference.



Fig. 18

6. Using the 10 mm wrench and Allen wrench, screw in the brush roll with screws and nuts previously used Fig. 19 .



Fig. 19

7. Install belt cover and secure with previously removed screws Fig. 20.

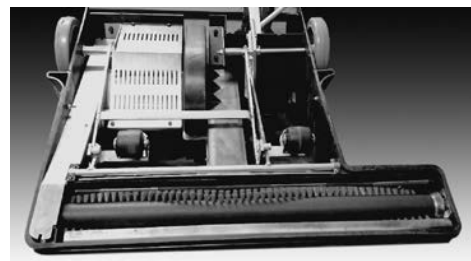

Fig. 20

MACHINE MAINTENANCE
CAUTION: Unplug the vacuum cleaner before performing the following steps.

FOR BEST PERFORMANCE

- Keep machine and all accessories clean and in good operating condition.
- Change vacuum bags and filters as recommended to maintain optimum cleaning efficiency.
- Always use genuine bags, filters and parts, as use of other products may result in poor cleaning or filtration performance. OEM filtration products are designed for maximum performance.
- Have machine checked periodically by an authorized service representative.
- Store machine carefully in dry area.
- For optimum cleaning performance and safety, follow your owner's manual.
- After each use, carefully wrap power cord around handle and check cord for wear or damage. If cord is damaged, have power cord replaced by an authorized service representative immediately.

TROUBLESHOOTING	
THE MACHINE DOES NOT TURN ON	
CAUSE:	SOLUTION:
1) The circuit breaker has tripped.	1) Reset circuit breaker.
2) Plug is broken or has loose contact.	2) Replace cord.
3) Branch circuit breaker has tripped.	3) Find circuit breaker box and reset.
THE BRUSH DOES NOT ROTATE	
CAUSE:	SOLUTION:
1) Broken brush belt.	1) Replace belt.
2) Brush obstruction.	2) Clear obstruction.
LOSS OF VACUUM SUCTION	
CAUSE:	SOLUTION:
1) Vacuum inlet blocked.	1) Visually inspect and clear blockage.
2) Defective motor.	2) Replace motor.
UNIT DOES NOT PICK UP	
CAUSE:	SOLUTION:
1) Strings/threads wrapped around brush.	1) Remove strings/threads.
2) Brush obstruction.	2) Clear obstruction.

For warranty information go to www.Powr-Flite.com

Powr-Flite[®]

A Tacony Company

3101 Wichita Court • Fort Worth, TX 76140-1755
1-800-880-2913 • Fax: 1-817-551-0719