

Powr-Flite[®]

COMMERCIAL FLOOR CARE EQUIPMENT

WET/DRY VACS
Models PF25, PF27, PF35, PF39
PF25HM, PF35HM



OPERATING INSTRUCTIONS

COMMERCIAL AND HOUSEHOLD
WET/DRY VACUUM CLEANERS

CONGRATULATIONS

YOU HAVE JUST ACQUIRED A HIGH QUALITY VACUUM CLEANER. PLEASE READ THIS MANUAL CAREFULLY, BEFORE OPERATING YOUR NEW VACUUM CLEANER. KEEP MANUAL ON HAND FOR FURTHER REFERENCES.



Read and follow all instructions, warnings and cautions before using this wet/dry vacuum.

READ ALL INSTRUCTIONS BEFORE USING!

Congratulations on purchasing a Powr-Flite wet/dry vacuum. Given proper care, this product will afford you many years of trouble-free operation. All parts have passed rigid quality control standards before being assembled to produce the finished product.

Prior to packaging, the vacuum cleaner is again inspected for assurance of flawless assembly. This unit is protectively packed to prevent damage in shipment. We recommend removal and inspection of unit upon delivery for possible damage in transit. Only a visual examination will reveal damage that may have occurred. If damage is discovered, immediately notify the transportation company that delivered your vacuum. As a shipper, we are unable to report claims for concealed damage. You must originate any claim within 5 days of delivery.

This manual is for your protection and information. PLEASE READ CAREFULLY since failure to follow precautions could result in discomfort or injury. When using electrical equipment, basic safety precautions should always be followed.

THANK YOU FOR CHOOSING POWR-FLITE!

TABLE OF CONTENTS

SAFETY PRECAUTIONS (English)	3
GROUNDING INSTRUCTIONS	4
OPERATING INSTRUCTIONS	
Dry Operation	5
Wet/Dry Operation	5
ASSEMBLY INSTRUCTIONS	
Vacuum Assembly	6
Tools & Attachment Assembly	6
REMOVAL OF LIQUIDS	7
FILTER INSTALLATIONS AND REMOVAL	7
SAFETY PRECAUTIONS (Spanish)	8
SAFETY PRECAUTIONS (French)	9
ILLUSTRATED PARTS LIST	10
Tool Kits	11
MAINTENANCE GUIDE	12

CARE OF THIS VACUUM CLEANER

Treat this unit as you would any other high grade precision made product. Dropping, unreasonable bumping across thresholds and other misuses may result in a damaged unit which will not be covered by warranty. When not in use, power cord should be wrapped around motor head for storage.

Read this manual completely before operating this vacuum. It is important to follow instructions in this manual to prevent the possibility of injury or damage to the user and/or machine.

IMPORTANT SAFETY PRECAUTIONS

WARNING!: To reduce the risk of fire, electric shock or injury

FOR DRY UNITS
Electric shock could occur if used on wet surfaces.
DO NOT expose to rain.
Store Indoors.

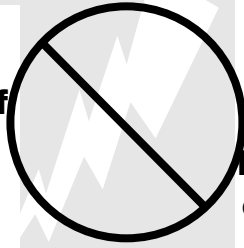

FOR WET UNITS
To avoid electric shock, **DO NOT** expose to rain. Store Indoors. Electric shock could occur if power nozzle is used on wet surfaces.

When using this electric vacuum / blower, basic precautions should always be followed, including the following:

- 1) **DO NOT** leave unit when plugged in. Unplug from outlet when not in use and before servicing.
- 2) **DO NOT** allow unit to be used as a toy. Close attention is necessary when used around or near children.
- 3) Use only as described in this manual. Use only manufacturer's recommended attachments.
- 4) **DO NOT** use with damaged cord or plug. If unit is not working properly because it has been dropped, dropped into water, left outdoors, or damaged in any way, contact a service center of Powr-Flite.
- 5) **DO NOT** pull or carry by cord, use cord as a handle, close door on cord, or pull cord around sharp edges or corners. Do not run unit over cord. Keep cord away from heated surfaces.
- 6) **DO NOT** unplug by pulling on cord. To unplug, grasp the plug, not the cord.
- 7) **DO NOT** handle plug or appliance with wet hands.
- 8) **DO NOT** put any objects into openings. **DO NOT** use with any opening blocked: keep free of dust, lint, hair, or anything that may reduce air flow.
- 9) Keep hair, loose clothing, fingers, and all parts of body away from openings and moving parts.
- 10) **DO NOT** pick up anything that is smoking or burning such as cigarettes, matches, or hot ashes.
- 11) **DO NOT** use without dust bag and/or filters in place for dry operation, and wet adapter for wet operation.
- 12) Turn off all controls before unplugging.
- 13) Use extra care when cleaning on stairs.
- 14) **DO NOT** use to pick up flammable or combustible liquids such as gasoline or use in areas where they may be present.
- 15) **DO NOT** use where oxygen or anesthetics are used.
- 16) **DO NOT** use an extension cord unless absolutely necessary. If an extension cord is used, then wire size must be #14 or larger and should not exceed 50 ft. in length. Extension cord must be a three-wire type to insure grounding protection.
- 17) Replace damaged or worn parts immediately with genuine original equipment parts to maintain safety.
- 18) This unit must be connected to a properly grounded outlet only. See grounding instruction. If your vacuum/blower has an outlet for a motorized power nozzle, always turn it off before connecting or disconnecting the motorized nozzle.

GROUNDING INSTRUCTIONS

DANGER: Improper use of the grounding plug can result in a risk of electric shock.

GROUNDING INSTRUCTIONS

This vacuum/blower must be properly grounded. If it should malfunction or breakdown, grounding provides a path of least resistance for electrical current to reduce the risk of electric shock. This machine is equipped with a cord having an equipment-grounding conductor and grounding plug. The plug must be inserted into an

appropriate outlet that is properly installed and grounded in accordance with all local codes and ordinances. If repair or replacement of the cord or plug is necessary, **DO NOT** connect the grounding wire to either flat blade terminal. The wire with insulation having an outer surface that is green with or without stripes is the grounding wire.

GROUNDING METHODS

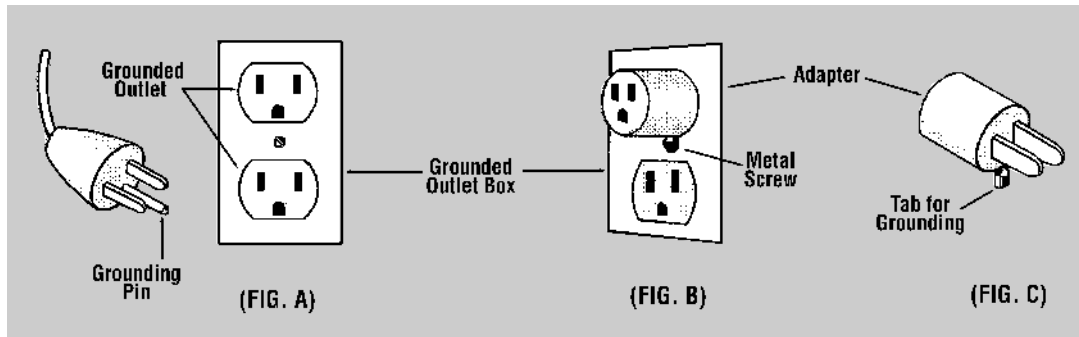

This unit is for use on a nominal 120 volt circuit, and has a grounded plug that looks like the plug illustrated in (Fig. A). A temporary adapter that looks like the adapter illustrated in (Fig. B&C) may be used to connect the plug to a 2-pole receptacle as shown in (Fig. B) if a properly grounded outlet is not available.

The temporary adapter should be used only until a properly grounded outlet (Fig. A) can be installed by a qualified electrician. The green color rigid ear, lug, or the like extending from the adapter must be connected to a permanent ground such as a properly grounded outlet box cover. Whenever the adapter is used, it must be held in place by a metal screw.

NOTE: In Canada, the use of a temporary adapter is not permitted by the Canadian Electrical Code.

WARNING!

Improper connection of the equipment-grounding conductor can result in a risk of electric shock. Check with a qualified electrician or service person if you are in doubt as to whether the outlet is properly grounded. **DO NOT** modify the plug provided with the appliance. If it will not fit the outlet, have a proper outlet installed by a qualified electrician.

OPERATING INSTRUCTIONS

FOR DRY (ONLY) OPERATION

Filter Installation

- 1) Disengage the three (3) retaining clamps that hold the motor head to the tank. Carefully remove the motor head and set aside.
- 2) Lift the cloth filter from the rim of the tank and remove any hoses, tools, etc. stored in the tank.
- 3) Install disposable paper filter bag as illustrated on page 10, (optional) set cloth filter bag on tank, replace motor head and snap down hold-down clamps.

CAUTION: Care should be exercised when handling motor head. Dropping motor head may cause permanent damage to internal components.

NOTE: Do not wash cloth filter. Shrinkage to the cloth and damage to the gasket can occur.

NOTE: In order to maintain maximum efficiency of this vacuum cleaner it is important to clean the cloth filter each time tank is emptied. To clean the cloth filter, shake off loose particles and brush exposed surface with a soft bristle brush.

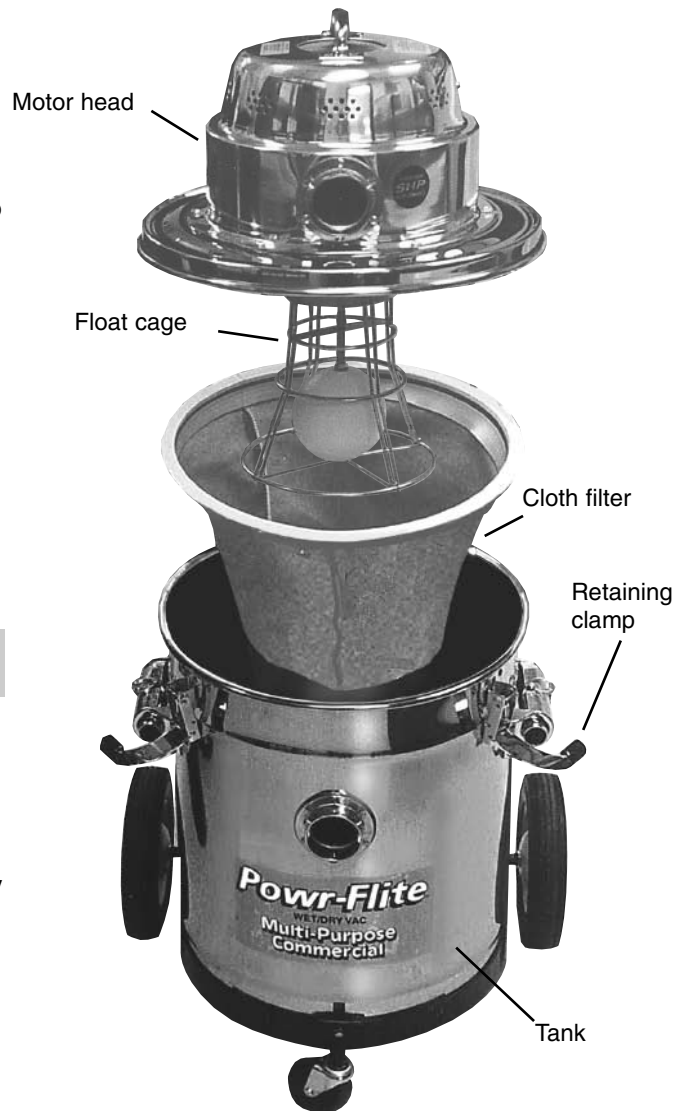

FOR WET/DRY OPERATION

Wet/dry vacuum cleaners are equipped with a by-pass motor, designed for wet or dry pick-up.

Wet Pick-Up Adaption

When ordered as a wet/dry vac, this unit is shipped with a dry filter for dry pick-up and a float cage assembly attached to motor head for liquid recovery. The safety float located in the protective frame of the float cage stops vacuum action of motor head when maximum recovery of liquid is reached.

- 1) Disengage the three (3) retaining clamps that hold the motor head to the tank. Carefully remove the motor head and set aside.
- 2) Lift the cloth filter from the rim of the tank and remove any hoses, tools, etc. stored in the tank.
- 3) Remove cloth filter from tank, replace motor head & cage and snap down hold-down clamps.

CAUTION: Excessive foam must be reduced with a chemical defoamer sprayed or poured into the tank. Powr-Defoamer part # SNQT is recommended.

Wet Pick-Up Maintenance

DO NOT store this unit with any liquid inside the vacuum tank. Before storing or converting over to dry pick-up, run emptied vacuum for approximately five minutes to eliminate moisture in the tank, hose, and attachments.

NOTE: Caution should be exercised when handling motor head. Dropping the motor head may cause permanent damage to internal components.

ASSEMBLY INSTRUCTIONS

VACUUM ASSEMBLY

TOOL CADDY

- 1) Attaches to top of handle facing tank.
- 2) Snap closures over top handle and Closures on each side of handle.

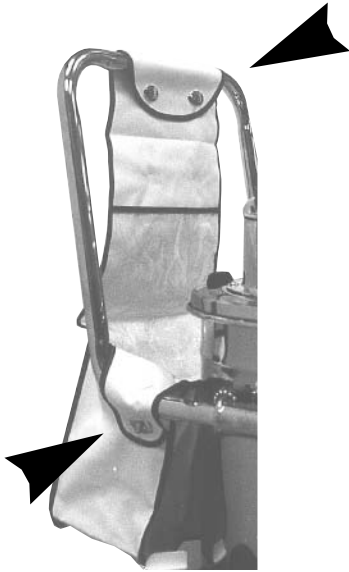

HANDLE

On 20 gallon units, this vacuum is shipped with the handle in storage position and must be moved to operating position. On 10 gallon units, the handle is shipped off and must be attached.

- 1) Firmly grasp speed pin on each side of handle and pull up and out.
- 2) Pulling handle slowly away from tank, align front handle holes with holes in handle bracket.
- 3) Insert speed pins through holes on both sides, locking handle in position. Attach tool caddy.

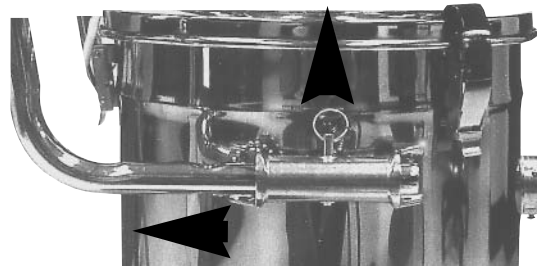

TOOLS & ATTACHMENT INSTALLATION & ASSEMBLY

HOSE CADDY

- 1) Standard equipment on 20 gallon units.
- 2) Shipped assembled.
- 3) Mounted to motor head with three tank mounted clamps.

HOSE CONNECTOR

The hose and swivel connector are pre-assembled at the factory. To attach swivel connector to intake fitting on vacuum tank:

- 1) Line up the slots in swivel connector with retaining rivets on intake.
- 2) Insert swivel connector and twist clockwise until rivets reset against slot end.

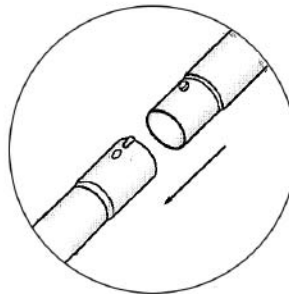

TO ASSEMBLE WAND

The two piece wand requires assembly.

- 1) Align the button lock of the upper wand section with the opening for button lock in the lower wand section.
- 2) Push sections together until lock is accomplished.

To attach hose to wand, slide free end of hose onto the grooved end of upper wand.

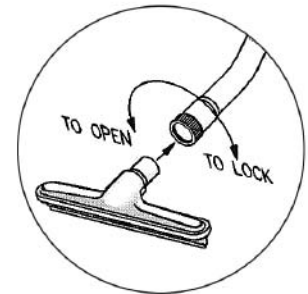

TO ASSEMBLE TOOLS

- 1) Turn wand nut counterclockwise approximately four complete turns.
- 2) Insert the tool into wand and coupling.
- 3) While holding tool in place, turn nut clockwise until wand nut is fully locked.

REMOVAL OF LIQUIDS

REMOVAL OF LIQUID FROM VACUUM TANK

Tanks without drain valves

- 1) Disengage hold-down clamps on tank.
- 2) Remove motor head and wet pick-up adapter, carefully place to one side.
- 3) Pour liquid from tank into suitable drain.

Tanks with drain valves

- 1) Center the drain valve over drain in floor.
- 2) To open the drain, turn valve counterclockwise and continue turning until desired flow is reached.
- 3) To close, make sure there are no obstructions that will prevent valve from sealing, then turn valve clockwise until it is fully closed and sealed

PAPER AND CLOTH FILTERS

FILTER INSTALLATION AND REMOVAL

To install paper and cloth filters

- 1) Expand filter bag pleats, then grasp scored ends of cardboard and pull forward completely onto inlet tube as close to tank wall as possible.
- 2) Position cloth filter assembly on the tank, then place motor head on tank and close clamps.

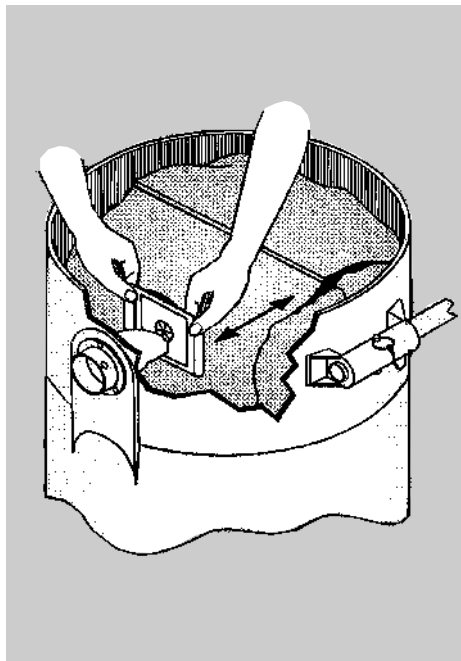

To remove loaded filter bag

- 1) Remove motor head and cloth filter assembly and lay cleaner on its side with inlet tube on top.
- 2) Pull bag out of tank using care not to puncture bag with inlet tube.
- 3) Re-seal cardboard flap that covered filter bag opening.
- 4) Install fresh new bag.

MEDIDAS DE SEGURIDAD

PELIGRO!: Para reducir el riesgo de incendio, descarga eléctrica o daño:

PARA UNIDADES EN SECO
Una sacudida eléctrica puede suceder si se usa en superficies húmedas.
NO SE exponga a la lluvia a guarde bajo techo.



PARA UNIDADES DE USO HUMEDA
Para evitar choque eléctrico NO exponga a la lluvia. Guarde bajo techo. Puede recibir una descarga eléctrica si la boquilla de potencia es usada en superficies húmedas

PARA SU SEGURIDAD

- 1) **NO DEJE** la aspiradora enchufada. Desconéctela cuando no la use y antes de darle servicio.
- 2) **NO PERMITE** que se use como juguete. Ponga atención cuando se use cerca de niños.
- 3) **USE SE SOLAMENTE** de acuerdo a las instrucciones y con accesorios recomendados por el fabricante.
- 4) **NO USE** con el cable o clavija dañados. Si la unidad ha sido golpeada, mojada, o dañada en algún modo llame al centro de servicio o Powr-Flite®.
- 5) **NO JALE** o carque del cable, no machuque el cable o lo estire sobre objetos filosos. **NO USE** la unidad sobre el cable.
- 6) **NO DESENCHUFE** jalando el cable. Para hacerlo jale de la clavija no del cable.
- 7) **NO TOME** la clavija o el aparato con las manos mojadas.
- 8) **NO TAPE** objetos en las ventilas. **NO USE** si alguna está tapada. Mantenga limpia de polvo, peluza o cualquier obstrucción
- 9) Mantenga el pelo, ropa suelta manos y partes del cuerpo lejos de las aberturas y partes móviles.
- 10) **NUNCA** aspire objetos que mandose o humeando como cigarrillos, cerillos o cenizas calientes.
- 11) **NO USE** sin bolsa para polvo o filtro para operación en seco o adaptador para líquidos para operación húmeda.
- 12) Apague todos los controles antes de desconectar.
- 13) Use extremo cuidado al limpiar en tapas.
- 14) **NO UTILIZE** la unidad para levantar líquidos inflamables o combustibles como gasolina; o use en áreas donde se encuentren estos líquidos.
- 15) Reemplacen las partes gastadas o dañadas inmediatamente para mantener la seguridad.
- 16) Esta unidad debe ser conectada a un enchufe correctamente aterrizado solamente. Vea las instrucciones de tierra. Si su aspiradora/soplador tiene un enchufe para una boquilla de potencia, apáguela siempre antes de conectar o desconectar la boquilla.
- 17) **NO USE** donde oxígeno o anestésicos sean empleados.
- 18) **NO USE** extensión eléctrica más que cuando sea absolutamente necesario. Si usa extensión, el cable debe de ser calibre #14 o mayor y no debe exceder 50 pies de longitud. El cable extensión debe ser de 3 polos para asegurar protección de tierra.

INSTRUCCIONES DE TIERRA

PELIGRO!

Una conexión incorrecta de tierra puede resultar en una descarga eléctrica. Consulte con un electricista calificado o persona de servicio si tiene duda acerca del enchufe y su tierra. No modifique el enchufe de la unidad. Si no encaja en el enchufe, haga instalar un enchufe apropiado por un electricista calificado.

IMPORTANTES MESURES DE SÉCURITÉ

AVERTISSEMENT!: Pour réduire les risques d'incendie, de choc électrique ou de blessure:

POUR APPAREIL SEC
Pour réduire les risques de choc électrique, ne pas aspirer de matières humides. Ne pas exposer à l'intérieur.



POUR APPAREIL HUMIDE
Pour réduire les risques de choc électrique, ne pas exposer à la pluie et garder l'aspirateur à l'intérieur.

POUR SÉCURITÉ

- 1) **NE PAS** laisser l'appareil sans surveillance lorsqu'il est branché. Débrancher lorsque l'appareil n'est pas utilisé et avant l'entretien.
- 2) **NE PAS** permettre aux enfants de jouer avec l'appareil. Une attention particulière est nécessaire lorsque l'appareil est utilisé par des enfants ou à proximité de ces derniers.
- 3) N'utiliser que conformément à cette notice avec les accessoires recommandés par le fabricant.
- 4) **NE PAS** utiliser si le cordon ou la fiche est endommagé. Retourner l'appareil à un atelier de réparation s'il ne fonctionne pas bien, s'il est tombé ou s'il a été endommagé, oublié à l'extérieur ou immergé.
- 5) **NE PAS** tirer, soulever ou traîner l'appareil par le cordon. **NE PAS** utiliser le cordon comme une poignée, le coincer dans l'embrasure d'une porte ou l'appuyer contre des arêtes vives ou des coins. **NE PAS** faire rouler l'appareil sur le cordon. Garder le cordon à l'écart des surfaces chaudes.
- 6) **NE PAS** débrancher en tirant sur le cordon. Tirer plutôt la fiche.
- 7) **NE PAS** toucher la fiche ou l'appareil lorsque vos mains sont humides.
- 8) **NE PAS INSÉRER** aucun objet dans les ouvertures. **NE PAS** utiliser l'appareil lorsqu'une ouverture est bloquée. S'assurer que de la poussière, de la peluche, des cheveux ou d'autres matières ne réduisent pas le débit d'air.
- 9) Maintenir les cheveux, les vêtements amples, les doigts et toutes les parties du corps à l'écart des ouvertures et des pièces mobiles.
- 10) **NE PAS** aspirer de matières en combustion ou qui dégagent de la fumée, comme des cigarettes, des allumettes ou des cendres chaudes.
- 11) **NE PAS** utiliser l'appareil si le sac à poussière ou le filtre n'est pas en place.
- 12) Mettre toutes les commandes à la position ARRÊT avant de débrancher l'appareil.
- 13) User de prudence lors du nettoyage des escaliers.
- 14) **NE PAS** aspirer des liquides inflammables ou combustibles, comme de l'essence, et ne pas faire fonctionner dans des endroits où peuvent se trouver de tels liquides.
- 15) Remplacez les parties vite à maintenir sécurité.
- 16) Ne brancher qu'à une prise de courant avec mise à la terre. Voir les instructions visant la mise à la terre.

INSTRUCTIONS VISANT LA MISE À LA TERRE

AVERTISSEMENT!

Un conducteur de terre mal raccordé peut entraîner un risque de choc électrique. Consulter un électricien ou un technicien d'entretien qualifié si vous n'êtes pas certain que la prise soit correctement mise à la terre. Ne pas modifier la fiche fournie avec l'appareil - elle ne peut être insérée dans la prise, faire installer une prise adéquate par un électricien qualifié.

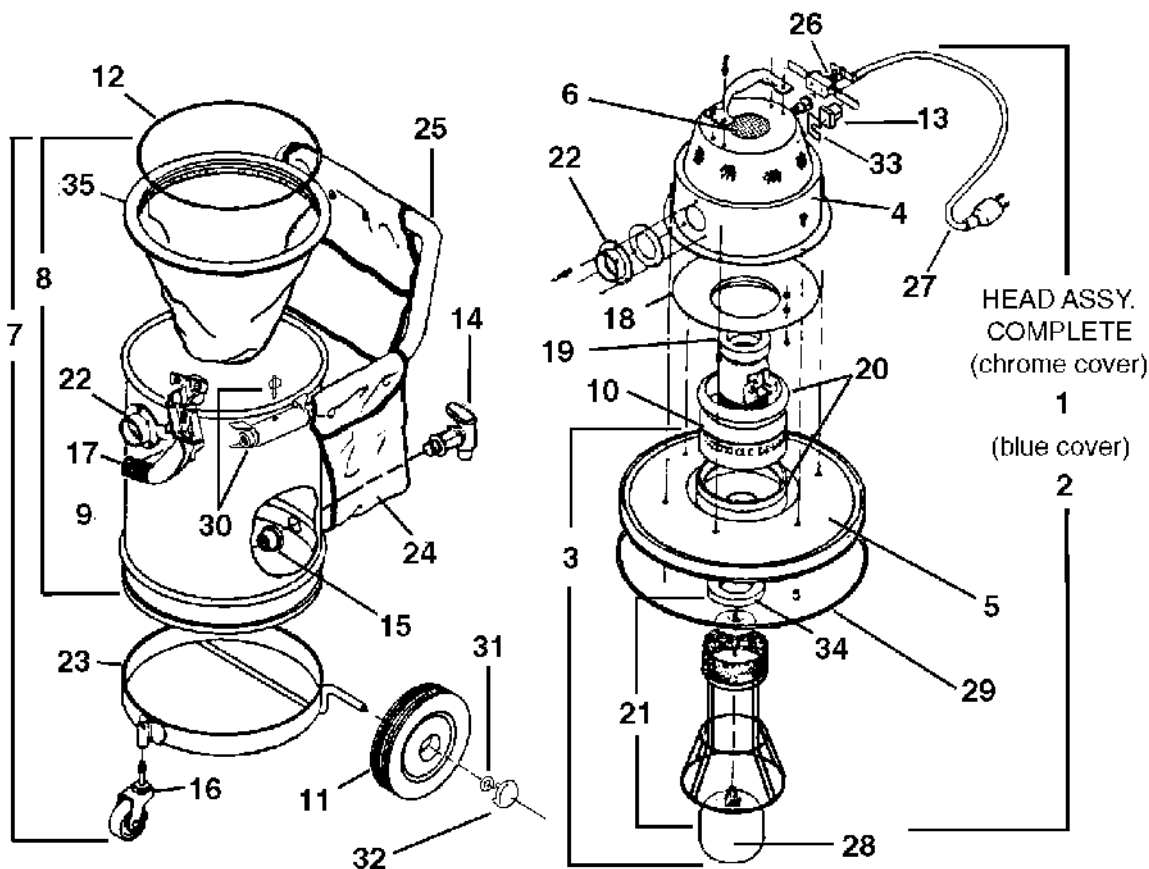

CAN ASSEMBLIES

ref #	order #	description and model numbers
7	C39M	can assembly, complete with hardware and wheels, models PF20, PF27, PF27HM
7	C40M	can assembly, complete w/wheels, dolly and handle, fits PF10, PF26, PF39
8	C41M	can assembly, with hardware and handle, no dolly or wheels, models PF10, PF39
7	C91M	20 gauge stainless can assembly, complete with hardware and wheels, models PF25, PF25HM
9	C95M	20 gauge stainless can assembly, no hardware, models PF25, PF25HM
7	C99M	20 gauge stainless can assembly, complete with hardware and wheels, models PF35, PF35HM

COVER ASSEMBLIES

ref #	order #	description and model numbers
5	C12M	top dome assembly with blower port and handle, fits all models
5	C16M	blue cover only, models PF20, PF27
3	C30M	chrome cover assembly, complete with float cage, models PF25
5	C42M	blue cover only, models PF10, PF39
6	C79M	blower screen (to direct air), all models
5	C83M	chrome cover only, models PF25
3	C97M	chrome cover assembly, complete with float cage, models PF35

COMPONENT PARTS

ref #	order #	description and model numbers
10	1969	lamb motor, 220V
10	1987	lamb motor, 110V
—	C1M	power head plug, black 13" 18/3
11	C5M	wheels
12	C10M	filter ring, 10 gallon filter
12	C11M	filter ring, 20 gallon filter
13	C17M	receptacle, power nozzle
—	C20M	vinyl coated wire hose cage, 10 gallon units
14	C21M	plastic drain valve
15	C22M	drain valve flange
16	C23M	caster
17	C25M	clamp assembly
—	C26M	vinyl coated wire hose cage, 20 gallon units
18	C27M	motor adapter
19	C28M	top motor gasket
20	C29M	motor gasket
21	C31M	float cage assembly
22	C32M	inlet fitting
23	C34M	dolly body, 20 gallon units
24	C35M	tool caddy, 20 gallon units
25	C36M	2 position push handle, 20 gallon unit
26	C37M	toggle switch
27	C38M	line cord
23	C43M	dolly body, 10 gallon units
—	C51M	gasket, AA140, AA141
29	C54M	top seal gasket
28	C70M	float ball only
30	C75M	pin and ring assembly, 2 position handle
31	C86M	panel nut, C5M
32	C87M	hub cap, C5M
33	C89M	retainer clip, C17M
—	C90M	strain relief
24	C92M	tool caddy, 10 gallon units
34	C94M	gasket, float ball
25	C98M	2 position push handle, 10 gallon units

HEAD ASSEMBLIES

ref #	order #	description and model numbers
2	C15M	head assembly, complete with blue cover and blower port, models PF20, PF27
1	C84M	head assembly, complete with chrome cover and blower port, models PF25
1	C96M	head assembly, complete with chrome cover and blower port, models PF35
—	HM7	head assembly, model PF35HM

TOOLS

ref #	order #	description and model numbers
B1	AA140	1-1/4" machine end hose coupling
A1	AA141	1-1/2" machine end hose coupling
A2	AA150B	1-1/2" x 10' hose complete, blue
B2	AA153	1-1/4" x 7' hose complete, grey
—	AA170	50' roll, 1-1/4" x 7/8" gasket
—	CT10	1-1/2" concrete tool, 12" wide mouth picks up debris quick and easy; use with CT9, CT14
—	CT11	1-1/2" tapered dusting brush, cast aluminum, 3" wide
—	CT11R	dust brush refill, CT11
—	CT12	1-1/2" overhead pipe tool, 4" to 6" diameter, use with CT6, CT7, CT15, or CT24 wands
—	CT13	1-1/2" crevice tool, 15" long, polished chrome finish
A4	CT30	floor tool, complete, 14"
A5	CT31	squeegee tool, complete, 14"
—	CT32	replacement floor brush, CT30
—	CT33	replacement squeegee blade, CT31
A6	CT34	rug tool, complete, 14"
—	CT35	replacement rug shoe, CT34
—	CT39	replacement brass bristle
—	CT41	1-1/4" squeegee tool
—	CT45	1-1/2" metal upholstery tool
—	CT51	double blade squeegee tool, complete, 14"
—	CT52	claw tool less brush strip, for vacuuming of asbestos (comes with hazardous duty vacs)
—	CT53	1-1/2" x 11" crevice tool (comes with hazardous duty vacs)
—	CT54	replacement squeegee blades, CT51
35	G752	10 gallon replacement cloth filter with gasket
35	G753	20 gallon replacement cloth filter with gasket
35	H818	10 gallon cloth filter with gasket
35	H819	20 gallon cloth filter with gasket
—	HM1	2-ply, 5-pak, totally enclosed paper bag, 10 gallon units
—	HM2	2-ply, 5-pak, totally enclosed paper bag, 20 gallon units
—	HM3	intermediary glass filter, 2-pak, 10 gallon units
—	HM4	intermediary glass filter, 2-pak, 20 gallon units
—	HM5	14" HEPA filter
—	HM6	16" HEPA filter
—	399PB	paper bag with elastic top, 5-pak
—	HMK1	conversion kit for wet pick up recovery, 20 gallon units
—	HMK2	conversion kit for wet pick up recovery, 10 gallon units

TK2 Fits Powr-Flite models PF25, PF27, PF35, PF39

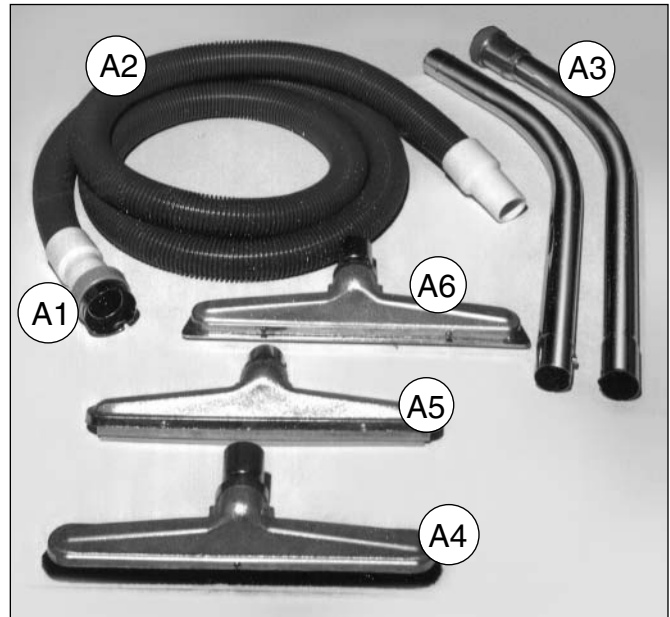

WANDS

ref #	order #	description and model numbers
—	CT9	6 foot straight extension wand, steel with swivel end
A3	CT14	1-1/2"x54" 2 piece chromed wand set
—	CT24	1-1/2"x54" 2 piece aluminum wand set
—	C24M	lock ring, above wands
—	C93M	screw on coupling, above wands, except CT7
B3	L1207	1-1/4" slotted wand, straight

MAINTENANCE GUIDE

Loss of Suction

CAUSE:

- 1) Full paper filter bag.
- 2) Dry filter assembly clogged.
- 3) Clogged hose or wand.
- 4) Tank rim is dented.
- 5) Loose or broken fan.
- 6) Motor not working.
- 7) Float not functioning.
tank is full.
- 8) Gasket worn.

SOLUTION:

- 1) Replace paper filter bag.
- 2) Clean cloth filter.
- 3) Remove obstruction.
- 4) Replace tank.
- 5) Contact manufacturer or service center.
- 6) Contact manufacturer or service center.
- 7) Check to see if ball on rod moves freely or
- 8) Replace gasket.

Motor is not running

CAUSE:

- 1) Broken switch.
- 2) Defective power cord.
- 3) Defective motor.
- 4) Blown fuse or tripped circuit breaker
at power source

SOLUTION:

- 1) Contact manufacturer or service center.
- 2) Contact manufacturer or service center.
- 3) Contact manufacturer or service center.
- 4) Contact manufacturer or service center.

Dust blowing from unit when running

CAUSE:

- 1) Full paper filter bag.
- 2) Paper filter bag not installed properly or
off inlet tube.
- 3) Cloth filter bag dirty.
- 4) Cloth or paper filter bag is torn.
- 5) Paper bag is not installed.

SOLUTION:

- 1) Replace filter bag.
- 2) Re-install or replace paper filter bag properly.
- 3) Clean cloth filter bag.
- 4) Replace filter bag.
- 5) Install paper filter bag.

Water blowing from unit when running

CAUSE:

- 1) Tank is full of liquid.
- 2) Sudsy or foamy liquid is being picked up.

SOLUTION:

- 1) Empty tank.
- 2) Add defoamer to tank.

WARRANTY

The manufacturer warrants to the original purchaser that products manufactured are free from defects of workmanship and material, provided such goods are installed, operated and maintained in accordance with written manuals or other instructions for a period of 1 year from date of purchase. In case you, as our customer, meet any trouble with your machine, contact your Powr-Flite® representative, who will be happy to be of service to you and will take care of the warranty settlement.

NOTE: Alterations and changes made to the machine without written approval of the manufacturer and use of unapproved spare parts will not be covered by warranty.

Powr-Flite
COMMERCIAL FLOOR CARE EQUIPMENT

A Tacony Company
3101 Wichita Court
Fort Worth, TX 76140
800.880.2913
www.Powr-Flite.com