

Powr-Flite®

COMMERCIAL FLOOR CARE EQUIPMENT

Commercial Sweeper

Model PS100 OWNERS MANUAL



IMPORTANT
READ THESE INSTRUCTIONS AND RETAIN FOR FUTURE REFERENCE

Before start-up please read these instructions! If, on unpacking the unit, you discover damage has been caused in transit please contact your sales office.

Before start-up please read the operating instructions for your unit and comply in particular with these safety instructions.

Application

Before use, check that the unit and operating equipment are in perfect condition and are safe to operate. Do not use the unit if it is not in perfect condition. The sweeping machine is not suitable for sweeping up liquids. Do not sweep up any poisonous, carcinogenic and hazardous substances or other dangerous materials. Do not sweep up any burning or glowing objects such as cigarettes, matches and similar items. Please use thick gloves when removing glass, metal or other materials from the dirt container. It is not permitted to remain in a dangerous area. It is forbidden to operate the unit in potentially explosive locations.

Operation

The operator must use the unit in accordance with the regulations. He/she must take local conditions into account when driving and be aware of other people, especially children, when operating the unit. Caution: Risk of crushing and shearing happening at the places marked (belt, side brush, dirt container). The unit must not be operated by children or juveniles.

Transport

Secure the unit before transporting.

Maintenance

Repairs may only be carried out by authorized customer service centers or by specialists in this field who are familiar with all the relevant safety regulations.

Accessories and spare parts

Only use accessories and spare parts which have been approved by the manufacturer. Original accessories and spare parts guarantee that the unit can be operated safely and without any breakdowns.

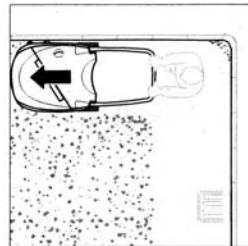
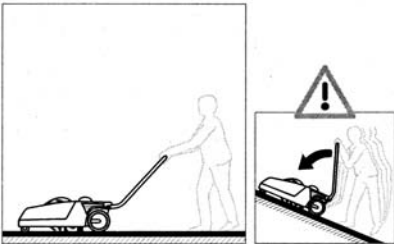
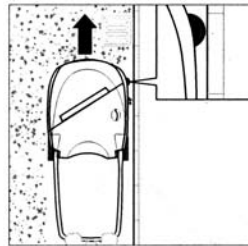
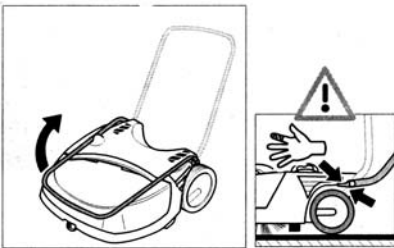

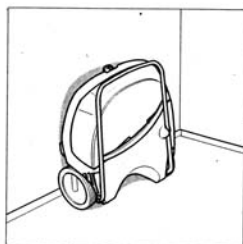
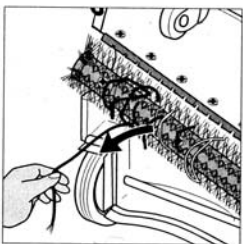
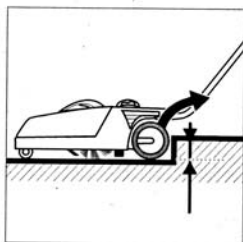
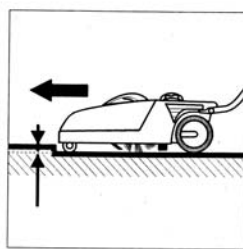

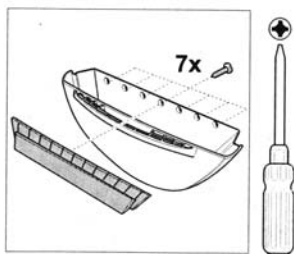
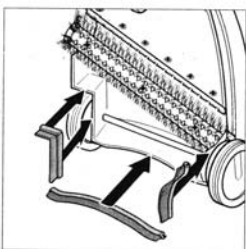
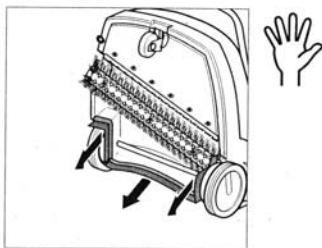
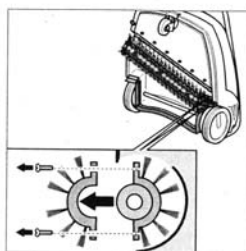
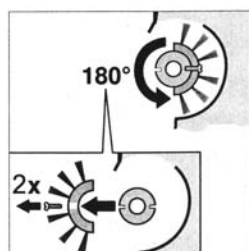
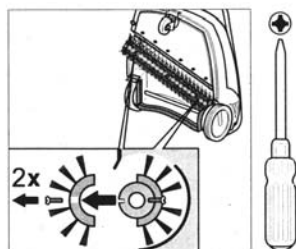
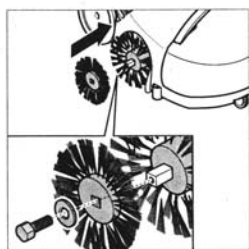
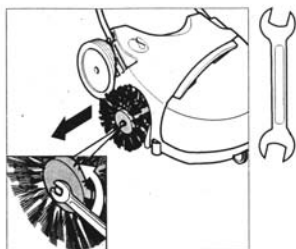

PS100 EXPLODED VIEW

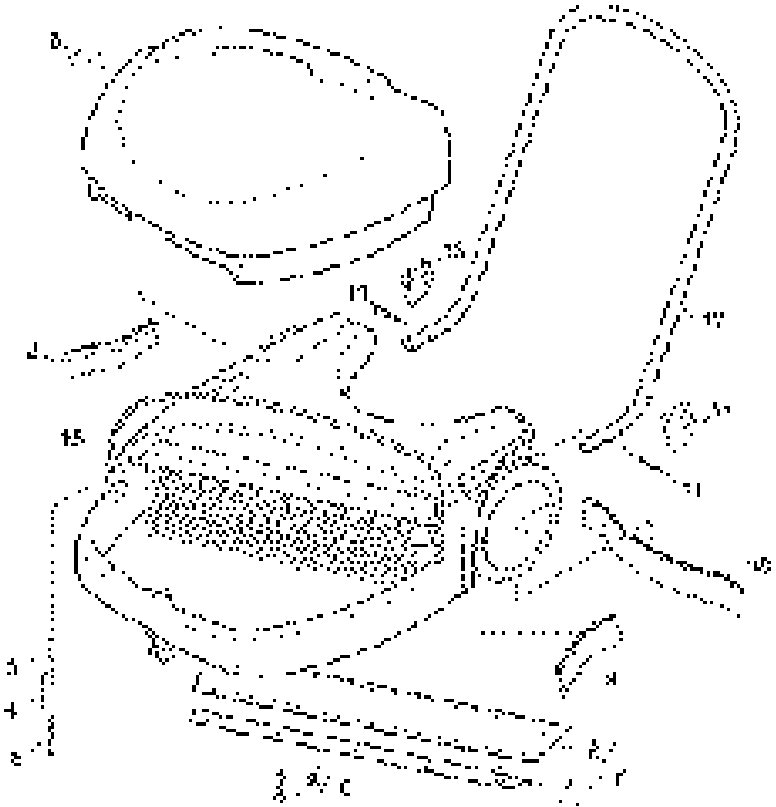

ref#	order	description
0	PS101	tank
2	PS107	seal
3	5.110-710.0	sleeve
4	5.515-045.0	roller
5	6.303-197.0	screw
6	5.031-449.0	wedge
7	PS102	rubber clip
8	PS122	5x16 screw
9	PS106	seal

ref#	order	description
10	PS108	seal
11	6.303-300.0	screw
12	PS103	shearing shackle
13	5.031-612.0	screen
14	5.031-613.0	screen
15	PS120	rubber gasket

PS100 EXPLODED VIEW

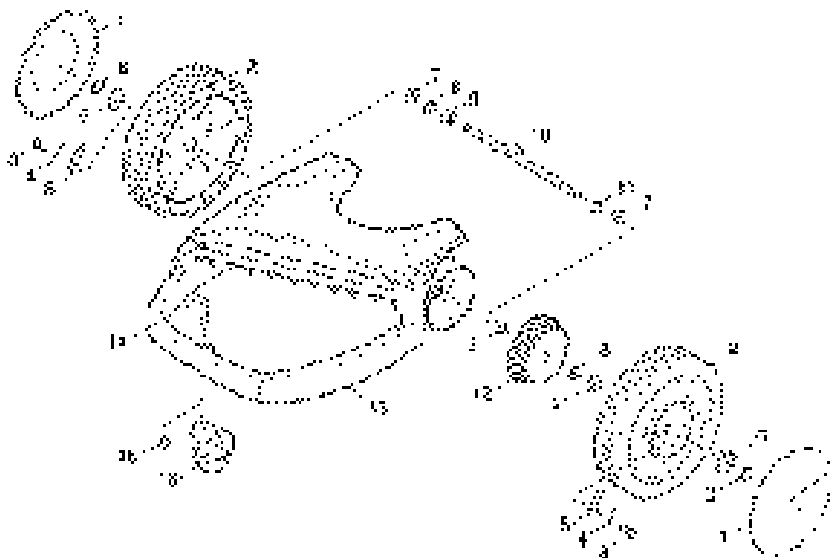

ref#	order	description
1	PS664	cover
2	PS109	wheel
3	PS662	fixing screw
4	PS661	leg spring
5	PS663	catch
6	PS450	free running
7	PS123	washer
8	7 343-003 0	spring clip
9	PS416	plain bearing

ref#	order	description
10	5.105-256.0	axle
11	7.343-205.0	lock washer
12	PS105	angular wheel
13	PS117	frame
14	PS114	cheese head screw
15	7.311-511.0	hexagon nut
16	PS110	castor

PS100 EXPLODED VIEW

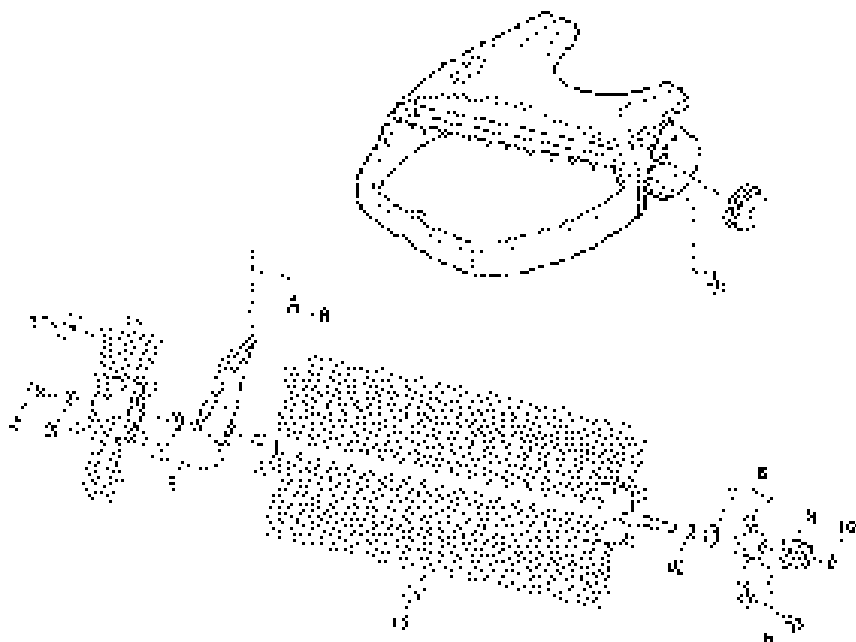

ref#	order	description
1	PS112	side reversing roll mill
2	PS113	cheese head screw
3	PS125	washer
5	5.250-085.0	end plate
6	PS122	screw

ref#	order	description
8	PS118	flange
g	PS104	angular wheel
10	7.343-003.0	spring clip
11	PS111	reversing rolling mill

Model PS100 OWNERS MANUAL

The Powr-Flite Limited Warranty

The manufacturer warrants to the original purchaser that products manufactured are free from defects, provided such goods are installed, operated and maintained in accordance with written manuals or other instructions for a period of 1 year from date of purchase on workmanship, motor, and parts.

