

MULTIWASH 14

OPERATOR'S MANUAL



WARNING: OPERATOR MUST READ AND UNDERSTAND THIS MANUAL COMPLETELY BEFORE OPERATING THIS EQUIPMENT.

CONTENTS

	Page
Product information	3
• Important safety advice	3
• Guidelines for the operator	3
• Working principle	3
• Know your machine	4
Preparing for use	5
• Assembly	5
• Brush selection guide	6
• Brush identification	6
Controls	7
Operating machine	8
Care of the machine	9
Maintenance	9
Accessories	10
After sales service	10
Electrical diagram	11
Technical specifications	12

IMPORTANT!

READ THESE INSTRUCTIONS AND RETAIN FOR FUTURE REFERENCE

PRODUCT INFORMATION

 This symbol is used in this manual to identify particular areas that are essential for your safety. Please pass all safety instructions on to other persons operating this machine.

The Powr-Flite floor cleaning machines are designed for use on smooth, even floors in indoor areas. They can be used on most floor surfaces including short pile carpet, wood, rubber and stone. They should not be used on rough uneven surfaces.

We are confident the machines will give years of trouble free service, coupled with ease of use and minimum maintenance.

Equipment must be operated, serviced and maintained in accordance with the manufacturer's instructions. If in doubt, contact the supplier of your machine.

The following instructions contain important information about the machine and safety advice for the operator.

IMPORTANT SAFETY INSTRUCTIONS

 Please read the following instructions completely before operating the machine. Any violation of the same will not only invalidate the warranty, but may also result in a safety hazard.

- The machine must be unpacked and assembled in accordance with these instructions before connecting to the electrical supply.
- This machine should always be connected to a fully grounded power supply of the right voltage and frequency.
- Keep the power supply cord away from moving parts. During operation, hazard may occur when running machine over the power cord.
- The machine must be disconnected from the power outlet (by pulling the plug out) before changing the brushes, cleaning the machine or performing routine maintenance.
- **Warning!** Only use brushes/accessories as per the instruction manual. Usage of any other brushes/accessories can cause safety problems.
- Periodically inspect the cord for possible damage. A damaged cord must be replaced with the proper cord available from the manufacturer or an authorized service agent.
- **DO NOT leave the machine connected to the power supply when not in use; always remove the plug from the power outlet.**

- **DO NOT** use where hazardous dust is present.
- **DO NOT** use machine near flammable liquids.
- **DO NOT** use in an explosive atmosphere.
- **DO NOT** use on a gradient or slopes.

GUIDELINES FOR THE OPERATOR

- Operators must be fully trained in accordance with these instructions, able to perform routine upkeep of the machine and correct selection of brushes.
- Operators should be physically capable to maneuver, transport and operate the machine.
- **DO NOT** run the machine dry, as this could damage the floor surface or the machine itself.
- Take adequate care to hold the machine firmly while installing and removing the brushes.
- Never use excessive foaming or highly corrosive cleaning solutions.
- While operating on a flooded floor, always ensure that the water level does not exceed 1/4" or 6 mm.
- **DO NOT** operate this machine on rough uneven surfaces e.g. industrial concrete floors.
- **DO NOT** clean the machine using pressure washers or steam cleaners.
- Ensure all parts are fitted properly before operation.

ELECTRICAL CONNECTIONS

Before connecting the machine to the power supply, check that your supply voltage corresponds with that marked on the rating label on the body of the machine.

THE WORKING PRINCIPLE

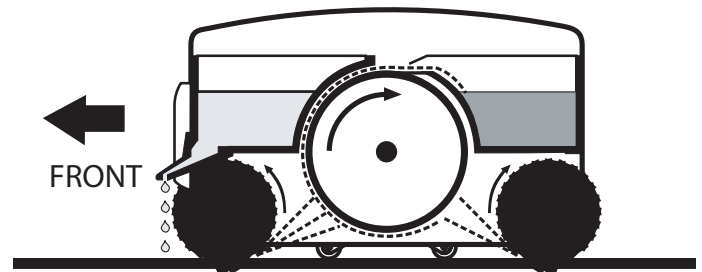

1. Cleaning liquid, in the solution tank, is applied to the floor by gravity through the solution manifold.
2. The contra rotating brushes scrub the floor and also throw the dirty water on the conveyor drum. The front brush does most of the scrubbing and drying. The rear brush completes the scrubbing and collects the remaining water off the floor.
3. A blade fitted to the dirty water tank wipes the drum and collects the dirty water.

KNOW YOUR MACHINE

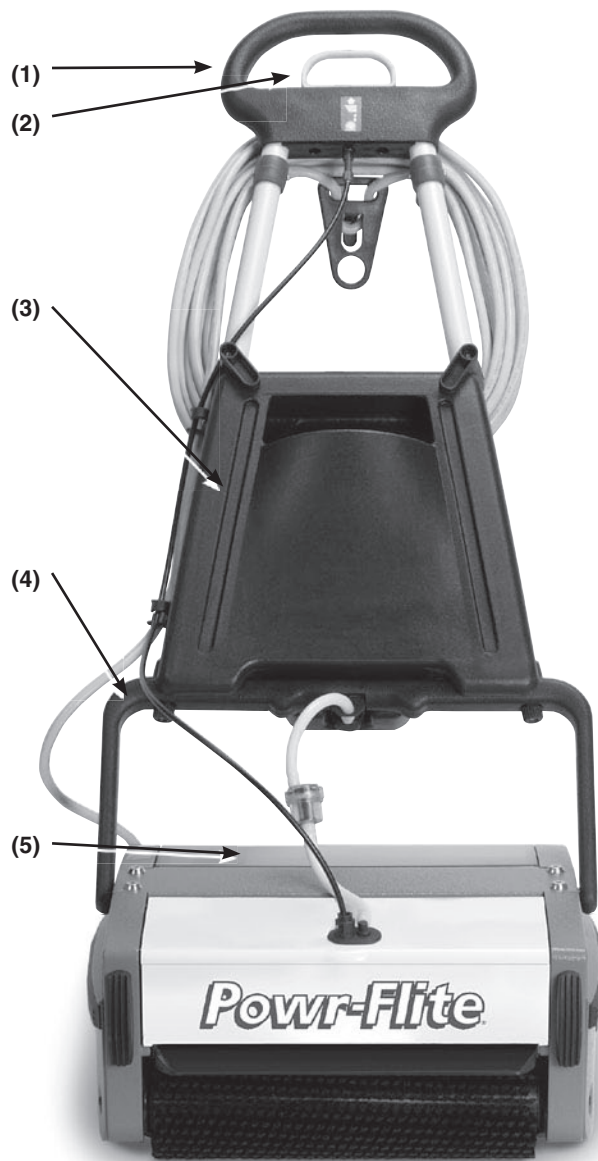

- (1) Top handle
- (2) Solution control handle
- (3) Solution tank
- (4) Bottom handle
- (5) Dirty water tank
- (6) Inline solution filter
- (7) Component housing
- (8) Conveyor drum
- (9) Brush
- (10) Handle release pedal

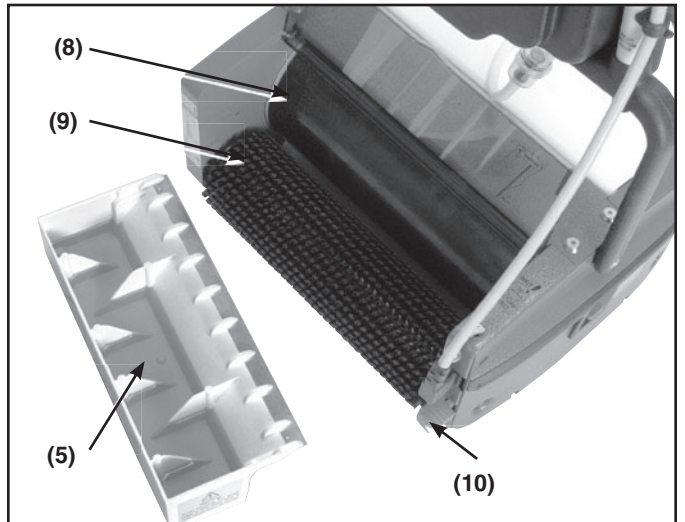
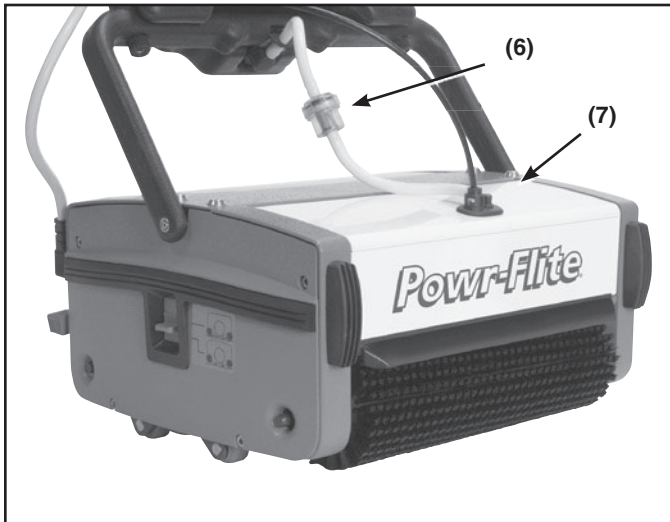



Warning! This machine is heavy. Do not attempt to lift the machine without assistance. Incorrect lifting techniques may result in personal injury.

PREPARING FOR USE

UNPACK

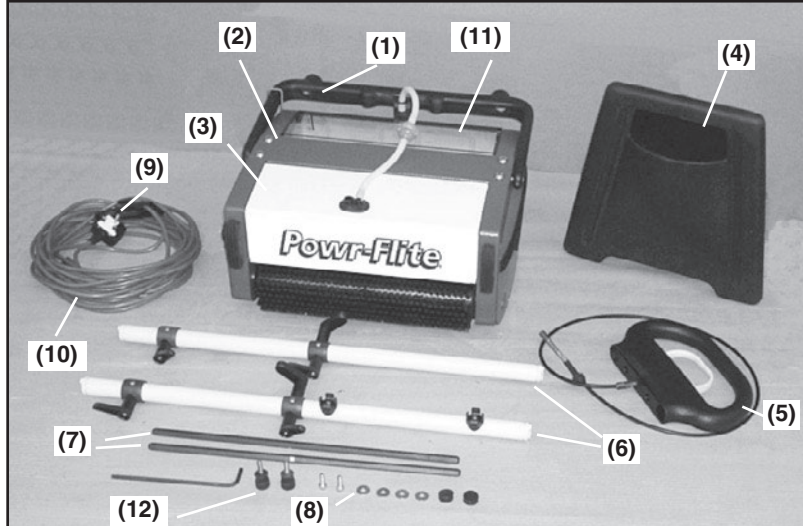

- (1) Bottom handle
- (2) Machine body
- (3) Component housing
- (4) Solution tank
- (5) Top handle and solution cable
- (6) Handle LH & RH
- (7) Brush shafts (2)
- (8) Screws & washers
- (9) Cable retainer
- (10) Power cord
- (11) Dirty water tank
- (12) Handle knobs

1. The Powr-Flite Multiwash 14 ships with the handle dismantled. To assemble, verify that all of the parts listed are included.
2. Remove the hook, which holds the bottom handle with the machine body, while holding the bottom handle.



Warning! Since the bottom handle is spring loaded, care must be taken when removing the hook to avoid sudden springing back, leading to possible injury to personnel.

ASSEMBLY



**RIGHT
BOTTOM
REAR**

**LEFT
BOTTOM
REAR**



1. Insert the two tubular handles into the bottom handle and secure them using handle knobs (12) by tightening lightly. Verify that the handles are assembled according to their marked position and the cable holding hooks are pointing towards the rear.
2. Slide the electric cable retainer into the top portion of RH handle.
3. Fit the top handle over the tubular handles and secure them with a washer and screw (2 sets). Ensure that the label on the top handle is facing the front of the machine. Now firmly tighten both the knobs and screws alternately. Insert the dummy caps provided to cover the screws (2) in the top handle.
4. Pass the free end of the pull cable through the plastic guide in RH Handle. Press and twist clockwise to firmly secure the cable end to the fitting in the component housing.
5. Fix the auxiliary tank firmly into the bottom handle by holding the top handle.
6. Rotate the knob to hold the auxiliary tank.
7. The brushes are only loosely packed in the machine for transit. The brush shafts must be fitted before operating the machine. Push the shafts through the brushes from the side of the machine. To remove brushes, push the brush shaft out from the side of the machine and remove the shaft. Normally the standard brush will be supplied with the machine. Brushes should be selected according to the type of floor surface to be cleaned and the type of dirt to be removed. Please refer Brush Selection Guide.
8. The machine is now ready for use.

BRUSH SELECTION GUIDE

Type of floor	First time cleaning	Maintenance cleaning
Grouted Tile, Ceramic, Mosaic, Wood, Sports floors, Rubber, Vinyl tile	Standard	Soft
Short Pile Carpet	Soft	Soft
Marble, Granite, Slate	Soft	Soft
Smooth Concrete	Hard	Standard
Escalator	Escalator	Escalator
Others	To suit individual floor conditions	

BRUSH IDENTIFICATION

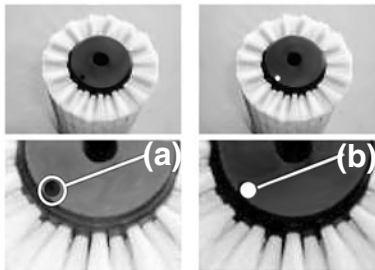

(a) Hole provided for plugging button.
 (b) Brush with button plugged.

This is applicable when the customer has more than one set of brushes of same type.

Distinct color coding make it easy to separate tools into their correct areas of use. Restroom brushes are kept in the restroom, kitchen brushes are kept in the kitchen - reducing bacteria cross-contamination between high and low-risk areas. RED, BLUE, WHITE and YELLOW brush buttons are packed with the machine. Simply plug the buttons into the hole in the brush as shown.

Clear identification, by color coding, helps to prevent cross contamination.

CONTROLS

On/Off Control

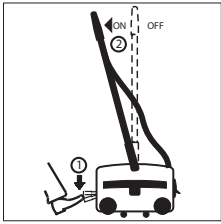

Release the pedal handle lightly with your foot (1), pull back the handle (2) to start the motor. The brushes and the drum starts rotating. Pulling the handle further without pressing the pedal, lowers the machine and engages the rotating brushes onto the floor. To stop working, take the handle to the vertical position.

Transport/Working Mode Control

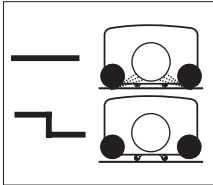

Slide this knob to TOP position (Working Mode) to operate the machine. Slide this knob to BOTTOM position to move the machine and park the machine.

Warning! Keeping the knob in the top position (working mode) and moving the machine will damage the brushes.

Brush Contact Control

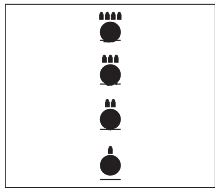

Brush contact with the floor is adjustable in 4 steps, contact is MINIMUM when the knob is fully down and MAXIMUM when it is fully raised. This helps you to compensate for the wear of brushes and also to control the scrubbing effect. If the machine does not move when the handle is lowered, slide the transport/working mode knob up one step.

Solution Control



By pulling the solution control handle up, the cleaning solution is dispensed on the floor. The solution stops once the solution control handle is released.

Pull Cable Connect / Disconnect Control

Insert the free end of solution cable into the valve body fitted in the auxiliary tank. Press and twist clockwise to secure the cable end. Similarly, press and twist counter-clockwise to disconnect the cable end.

Motor Circuit Breaker

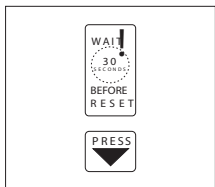

In the event of motor getting overloaded due to improper power supply or unexpected obstruction to the brush/drum rotation, the circuit breaker trips and protects the motor from damage. If this happens, identify the cause, correct it and, reset the breaker after minimum of 30 seconds from tripping by pressing the circuit breaker button manually and continue working.



Important - Should the machine fail to operate, contact the supplier from whom you purchased the machine.

OPERATING THE MACHINE

Before the washing operation starts



Warning! Pre-sweep the floor to remove debris before using the Multiwash.

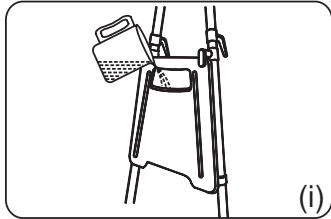

1. Verify that the brushes are fitted properly.
2. Fill fresh water tank with cleaning solution.
3. Insert the plug into grounded 3-pronged outlet.

Recommended washing sequence

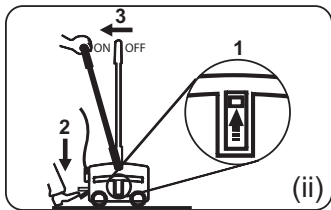

1. Start the machine by pressing the handle release pedal and pulling the handle back (Fig-ii).
2. Move forward, while sparingly pulling the solution control handle (Fig-iii). This handle should only be pulled intermittently, based on the floor type and the amount of soil on the floor. For tiled or stone floors, apply very little water.
3. Stop the solution discharge approximately 12 inches before the end of forward motion. Continue to move forward up to the wall without pulling the pull handle.

Model (Standard)

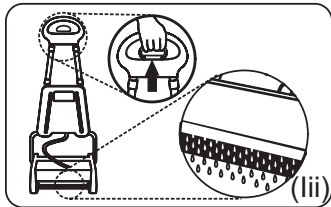

4. Pull the machine backwards in the same track, but without discharging any solution. When you reach the starting point, change the track and repeat steps 2 through 4. When you are changing the track allow some overlap with the cleaned area. In case of large halls take a U-turn and move forward. If quick drying is required, move on the same track, without discharging any solution (Fig-iv).

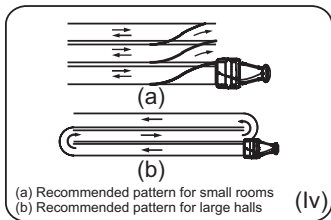

5. When you are finished with the cleaning operation, switch off the machine and unplug the power cord. Lift the recovery tank lid and remove the recovery tank. Empty the tank, rinse with clean water and clean off the steel wiper blade before replacing the tank on the machine.

IMPORTANT — Dispose of dirty water in accordance with all local, state and federal hazardous material disposal regulations.

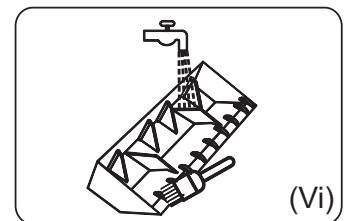
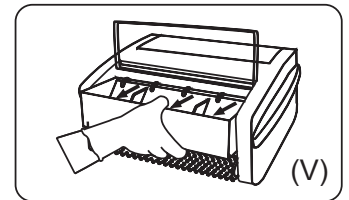

Warning! Avoid touching the sharp edge of dirty water tank. It may cause injury to hands.

CARE OF THE MACHINE



Warning! Before cleaning the machine, switch off the machine and unplug from the electrical supply.

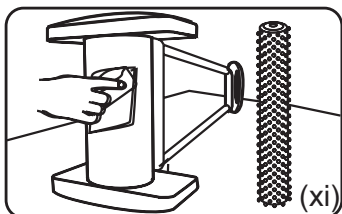
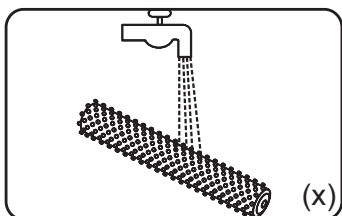
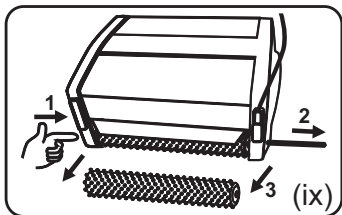
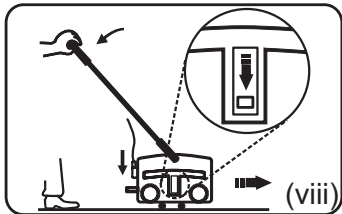

1. Move the Transport / Working mode control knob to BOTTOM (Transport) position (Fig-viii).
2. Disconnect the power supply by unplugging the electrical plug and wind the cable over cable holders in the handle.
3. Pull out the dirty water tank and wash it completely.
4. To prevent possible clogging of filter, drain cleaning liquid and keep the fresh water tank clean.
5. Remove the brushes by pushing the brush shaft out (Fig-ix).
6. Wash the brushes either by dipping in a bucket/sink or in running water (Fig-x).
7. Turn the machine sideways and wipe clean the conveyor and machine body with a damp cloth (Fig-xi).
8. Re-install the brushes after washing. It is easier to push the brush shaft from the right hand side (identified by the electrical cable).
9. Store the machine in a dry indoor area only.

MAINTENANCE



Warning! Before undertaking any maintenance operations or adjustments, switch off the machine and unplug from the electrical supply.

- **Power cord**

Regularly inspect power cord, plug and strain relief for damage or loose connection.

- **Brushes**

For maximum life, wash the brushes regularly. Ensure machine is in Transport mode when not in use. Store additional brushes in a vertical position to avoid bending of bristles. Check for permanent bending of bristles in a particular direction. This may occur if the machine is operated for several days without removing the brushes, which is not recommended. If this occurs, reverse the brush so that the bent bristles are automatically straightened.

- **Wiper Blade**

After years of use the wiper blade may wear. If this occurs the water collection performance will decrease. It should be replaced by an authorized service agent.

- **Solution tank filter**

The filter prevents clogging of the drip holes in the tank. Periodically clean the filter to ensure uniform discharge of liquid. In case of non uniform discharge from the drip holes, back flush the tank in running water. Clean the drip holes using wire or a blunt pin.

ACCESSORIES

Transport Cart

The transport cart provides for ease of movement when transporting the machine.



Warning! Empty all liquid from the machine before using the transport cart.



Using the transport cart

1. With the machine handle in the upright position place the cart centrally alongside the machine.
2. By holding the machine firmly, tilt the handle away from your body. Slide the cart base under the machine and strap it to the machine with the velcro.
3. Ensure that the velcro strap is securely wrapped around the bottom handle.
4. Now the cart is ready to use. The machine can then be maneuvered easily while holding the top handle.

Side Brush

To clean up to walls, the side brush may be used. Switch off and unplug the machine before fitting the side brush.



Warning! Do not use side brush in a room with no wall skirting, otherwise, the wall may get dirty.

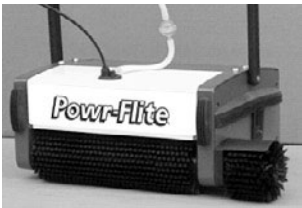

Fitting the side brush

1. Remove the front brush and brush shaft.
2. Fix the shield assembly on the side plate.
3. Insert the side brush through the shield and main brush.

Using the side brush

1. Tilt the machine at an angle, move forward. This way, the dirty water thrown by the side brush will be collected by the rear brush.
2. Use side brush only for washing the edges

AFTER SALES SERVICE

Should you require after sales service please contact the supplier from whom you purchased the machine, who will arrange service. Repairs and servicing should only be performed by trained staff. Improper repairs can cause considerable danger to the user and void any warranty.

WARRANTY

The manufacturer warrants to the original purchaser that products manufactured are free from defects of workmanship and material, provided such goods are installed, operated and maintained in accordance with written manuals or other instructions for a period of 5 years from date of purchase on housings and frame, and 1 year on parts and workmanship. In case you as our customer, meet any trouble with your machine, contact your Powr-Flite representative who will be happy to be of service to you and will take care of the warranty settlement.

NOTE: Alterations and changes made to the machine without written approval of the manufacturer and use of unapproved spare parts will not be covered by warranty.

ELECTRICAL DIAGRAM

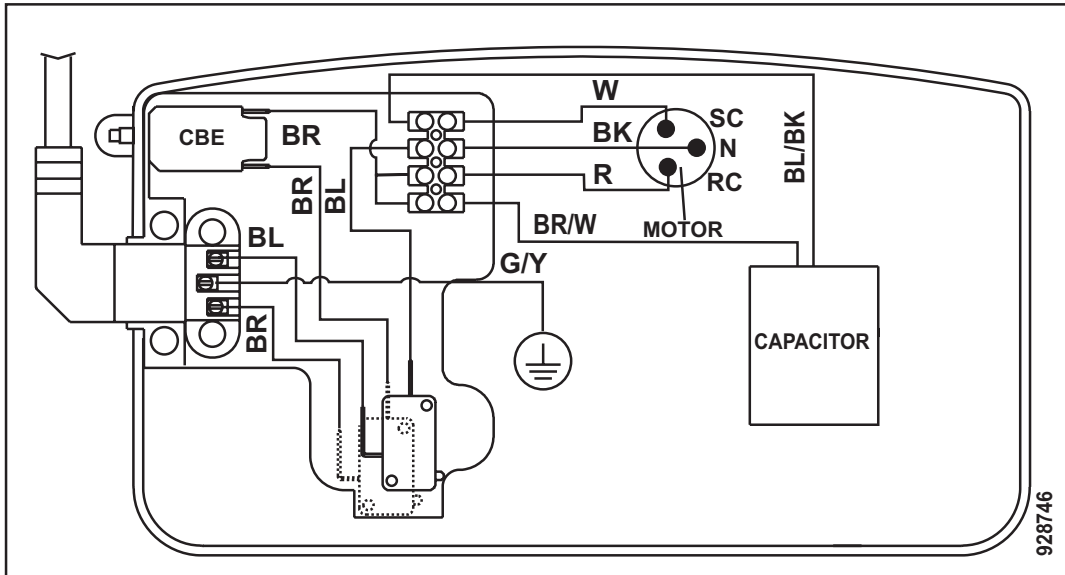

1. Electrical layout

Diagrams are made available in the cover (Power cord side) of the respective machine for service purpose.



Warning! Any service or attempt to service by persons other than authorized servicing agent will invalidate the warranty.

Abbreviations given in the diagram as listed:

Abbreviation / Symbol	Description	Abbreviation / Symbol	Description
CBE	Circuit Breaker	G/Y	Green / Yellow
BR	Brown	SC	Starting coil
BL	Blue	RC	Running coil
W	White	N	Normal
BK	Black		Ground
R	Red		

ADDITIONAL INFORMATION-WEEE (WASTE OF ELECTRIC AND ELECTRONIC EQUIPMENT)



The symbol  on the product or its packages indicates that the product may not be treated as house hold waste. Instead it shall be handed over to applicable collection point for recycling of electrical and electronic equipment. By ensuring this product is disposed of correctly, you will help prevent potential negative consequence of the environment and human health, which could otherwise be caused by inappropriate waste handling of this product, please contact your local city office or household waste disposal service.

TECHNICAL SPECIFICATIONS

Specification	Units	Multiwash 14	
Cleaning capacity*	square feet/hr	5500	
Cleaning width	inches	14	
Fresh water tank capacity	gallons	1	
Overall dimensions			
Height with handle	inches	44"	
Height without handle	inches	8.5"	
Width	inches	17.5"	
Length	inches	15"	
Weight	lbs.	53 lbs.	
Noise level (see note 1)	dB(A)	69	
Handle vibration (see note 2)	m/s ²	<2.5	
Model	Power supply	Power (W)	Brush speed (rpm)
Multiwash 14	110 VAC ±6%, 60Hz, Single Phase	750	780

*Theoretical

Note:

- Noise levels measured at a distance of 3.28 feet from machine and 5.25 feet above floor, when washing a hard floor. Measurements recorded using a hand held meter.
- Handle vibration does not exceed 2.5 m/s², when operating on a smooth hard surface.
- Above dimensions are approx. Since the companies policy is to continuously improve the product, there could be changes without prior notice.

Powr-Flite[®]

COMMERCIAL FLOOR CARE EQUIPMENT

A Tacony Company
3101 Wichita Court • Ft. Worth, TX 76140-1755
Tel: 800.880.2913 • Fax: 817.551.0700
www.Powr-Flite.com
